



**User Manual**  
**Deluxe Plus attachment kit**



**Model Number:**

**KIT-LV30/35/40-DP**

# Index

1. Specifications .....	3
2. Low-Voltage Hose .....	4
3. How to use the wand .....	5
4. Included cleaning tools .....	6
5. Easy Storage included.....	7



# 1. INCLUDED IN THE KIT

1. Low-Voltage hose with ON/OFF switch
2. Adjustable wand
3. Dusting brush
4. Upholstery brush
5. Crevice Tool
6. 12" Floor brush
7. Air-Driven Carpet beater
8. Accessory bag
9. Hose Hanger

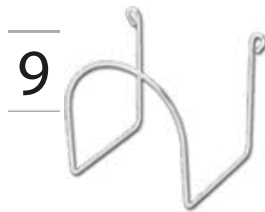
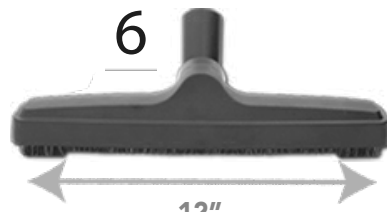
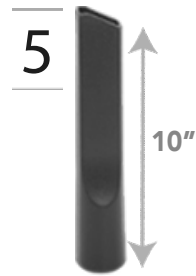

## 2. LOW-VOLTAGE HOSE

### 2.1 Compatibility

The hose is compatible with most wall inlets. Inlets must have a 1.5" inner diameter **(A)** in order for the hose to fit, and must have 2 low-voltage pins/metal prongs **(B)** in order to turn the hose ON/OFF from the switch located on the hose handle.

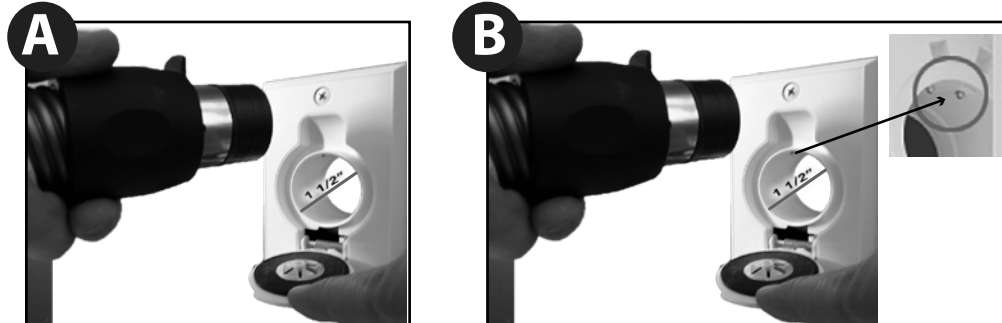

### 2.2 Connecting the hose to the wall inlet

The hose end cuff must be connected as shown in the picture below. The black part on the end cuff must be well aligned with the 2 pins inside the inlet **(C)**. The plastic square must be facing up **(D)**.

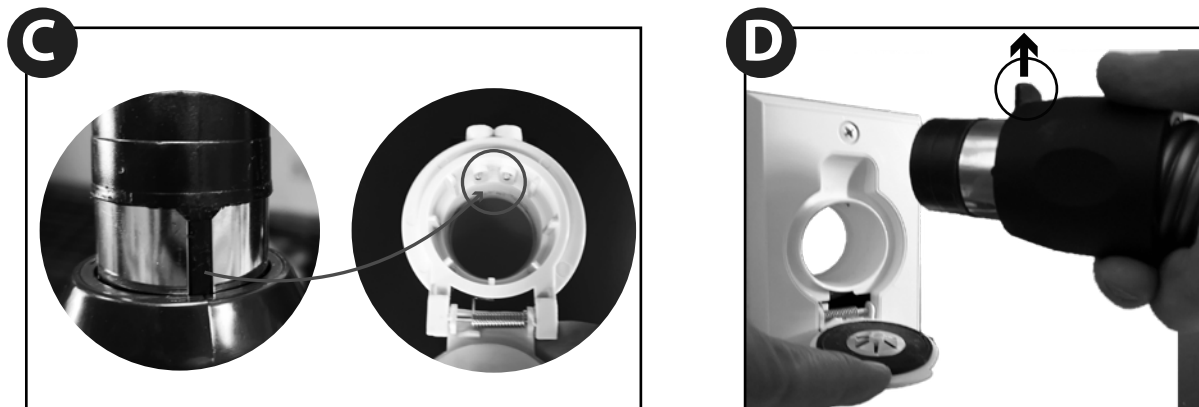

### 2.3 Starting and stopping your central vacuum

If your inlets have 2 low-voltage pins inside as demonstrated in step 2.1, you will be able to start and stop your central vacuum directly from the switch on the hose handle.





# 3. HOW TO USE THE WAND

## 3.1 How to extend the wand

To extend the wand, simply push on the button **(E)** and pull on the wand **(F)** at the same time

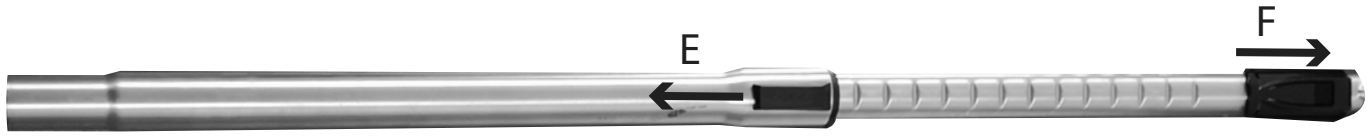

## 3.1 How to connect the wand to the hose nozzle

Align the hose nozzle button **(G)** with the lock button on the wand **(H)** and push the nozzle into the wand until you hear a "click"

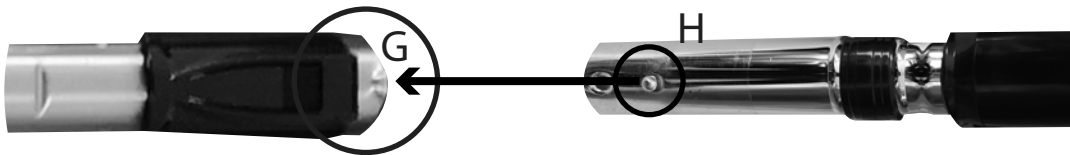

## 3.1 How to connect the different attachment tools

Insert the other end of the wand into the port on the brushes

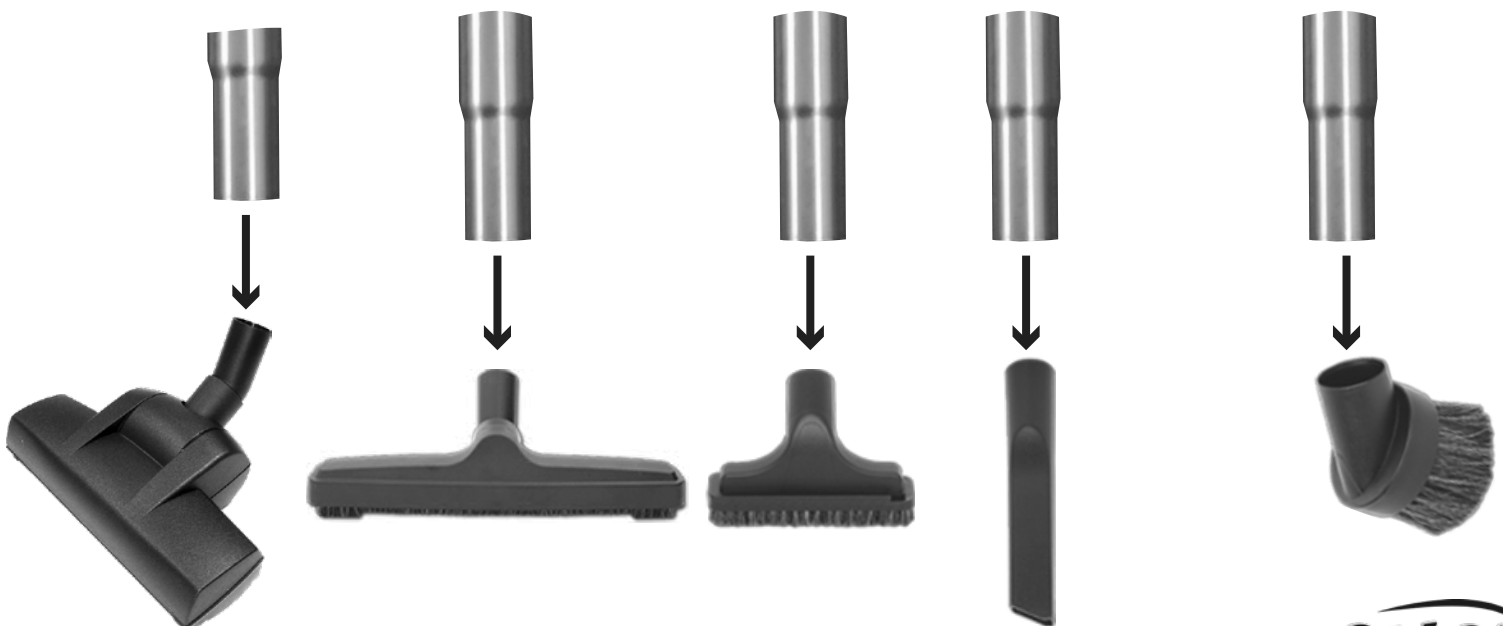

## 4. INCLUDED CLEANING TOOLS

### 4.1 Air-driven carpet beater

NON-ELECTRIC carpet beater - Ideal for area rugs and low pile carpets



Roller brush activating by vacuum suction



### 4.1 12" Superior Floor brush

Ideal for hard surfaces. Made of horse hair - Will not scratch your floor

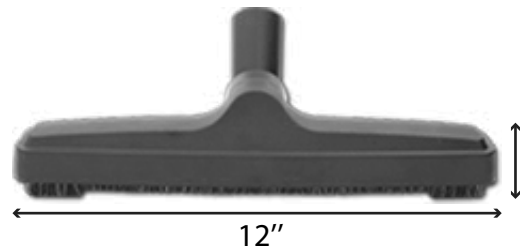

### 4.2 Dusting brush

Made of horse hair - Delicate and soft on furniture



### 4.3 Upholstery brush

Made of horse hair - Perfect for delicate furniture



### 4.4 Crevice tool

Ideal for cleaning nooks and crannies.

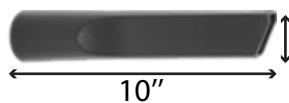

# 5. EASY STORAGE INCLUDED

## 5.1 Tool Cady

The perfect accessory to have your small tools always accessible.

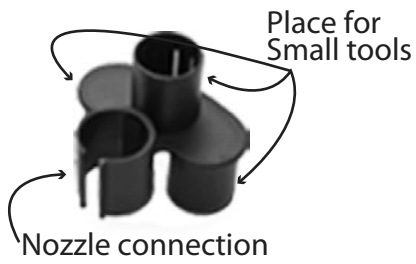

## 5.2 Chrome hose hanger

The perfect accessory to store your hose neatly.

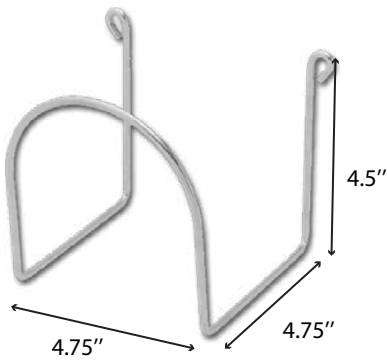

## 5.3 Accessory bag

2 Large pockets to easily store your accessories without making a mess in your storage room.





**USA: [www.myovo.net](http://www.myovo.net)**  
**Canada: [www.myovo.ca](http://www.myovo.ca)**  
**1 800 776-7891**

---

**TO REGISTER YOUR WARRANTY:**  
**USA: [myovo.net/register](http://myovo.net/register)**  
**Canada: [myovo.ca/registrer](http://myovo.ca/registrer)**

---

**TO GET THE PARTS OR OTHER PRODUCTS:**

**USA: [myovo.net](http://myovo.net)**  
**CANADA: [myovo.ca](http://myovo.ca)**  
**EMAIL AT: [info@myovo.net](mailto:info@myovo.net)**  
**TOOL FREE: 1-800-776-7891**

---

**2044 Autoroute 440 Ouest, Laval, QC, H7S 2M9**